

Pikkus / Length (A) (min/max) = 450 - 3000 4000 mm when required

Laius / Width (B) (min/max) = 450 - 900 mm

Sügavus / Height (C) (min/max) = 17 - 60 mm

Materjali paksus / Thickness range $t = 1,0 - 1,5$ mm

$D1 / D2 = 20$ mm

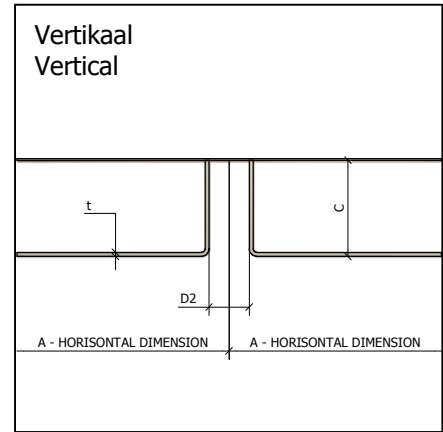
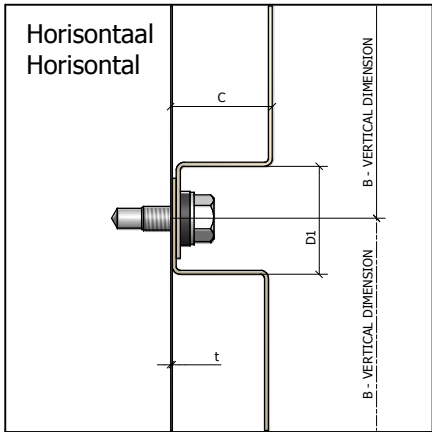
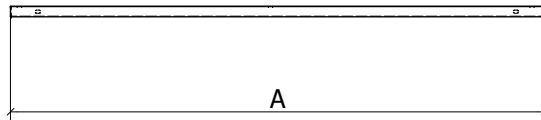
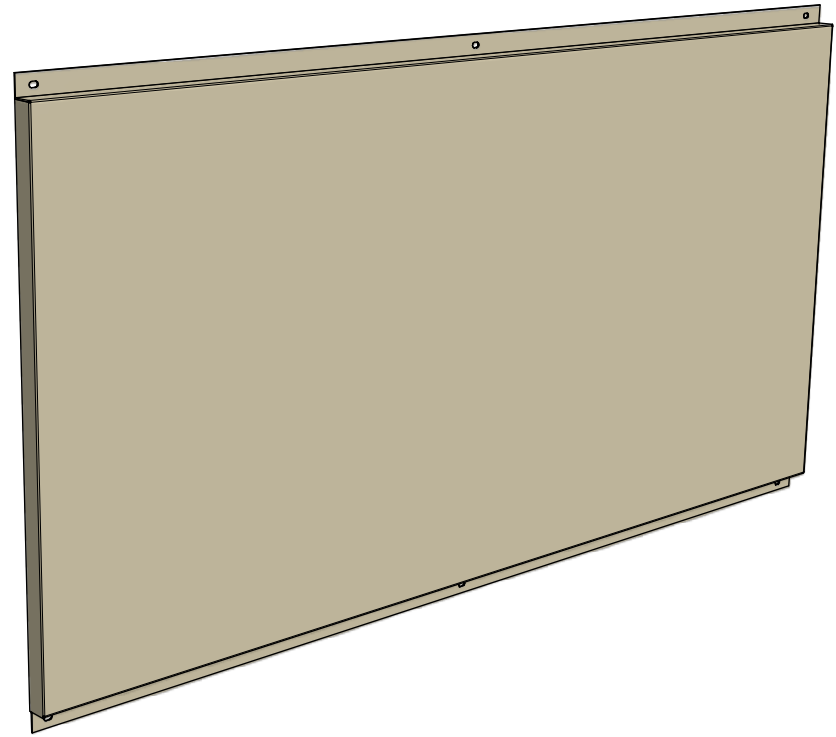
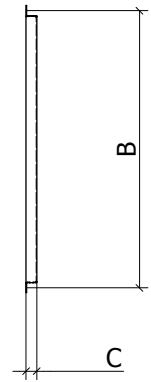
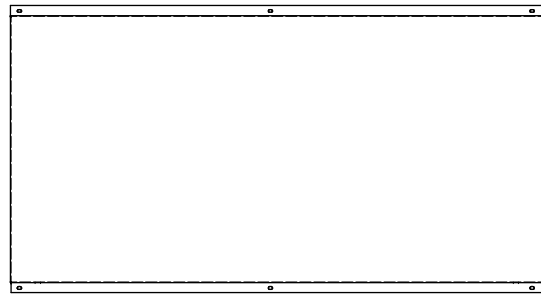

Pikkus / Lenght (A) (min/max) = 450 - 3000 4000 mm when required
Laius / Width (B) (min/max) = 450 - 900 mm
Sügavus / Height (C) (min/max) = 17 - 60 mm
Materjali paksus / Thickness range t = 1,0 - 1,5 mm
D1 = 20 mm / D2 = 0 - 30 mm

PARMET

Type :

L-102

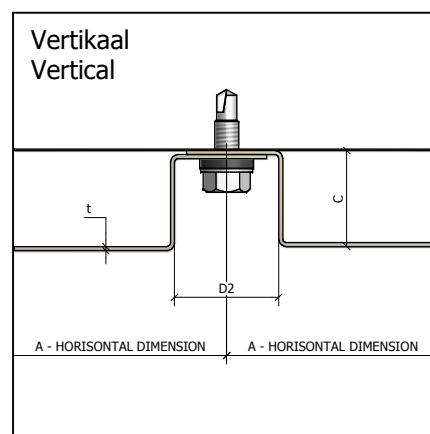
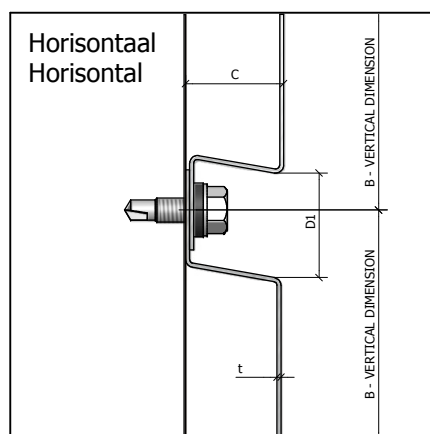
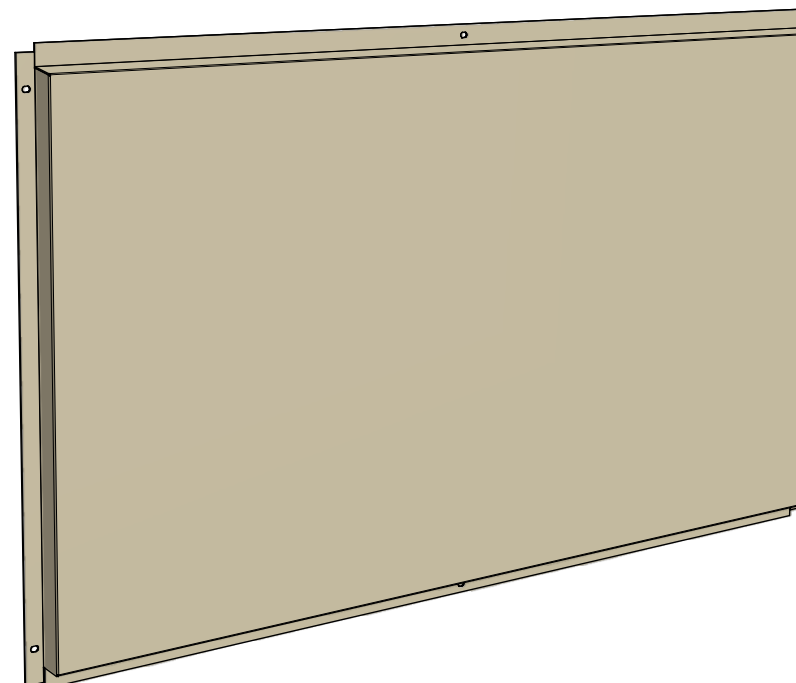
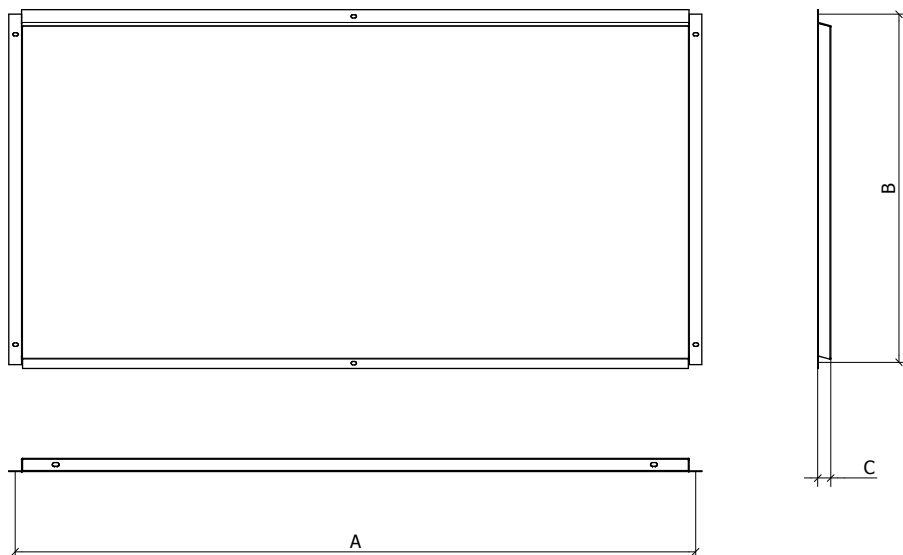

Pikkus / Length (A) (min/max) = 450 - 3000 4000 mm when required

Laius / Width (B) (min/max) = 459 - 900 mm

Sügavus / Height (C) (min/max) = 17 - 60 mm

Materjali paksus / Thickness range $t = 1,0 - 1,5$ mm

$D1 / D2 = 20$ mm

PARMET

Type :

L-105

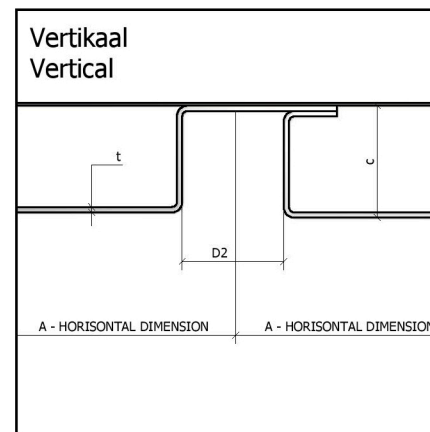
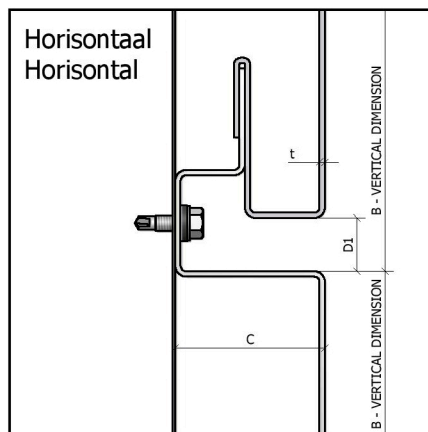
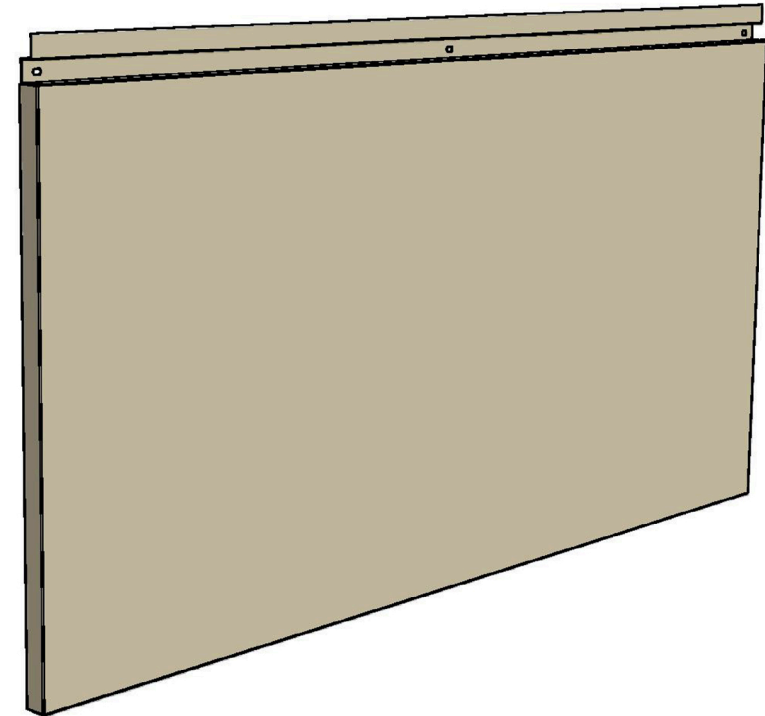
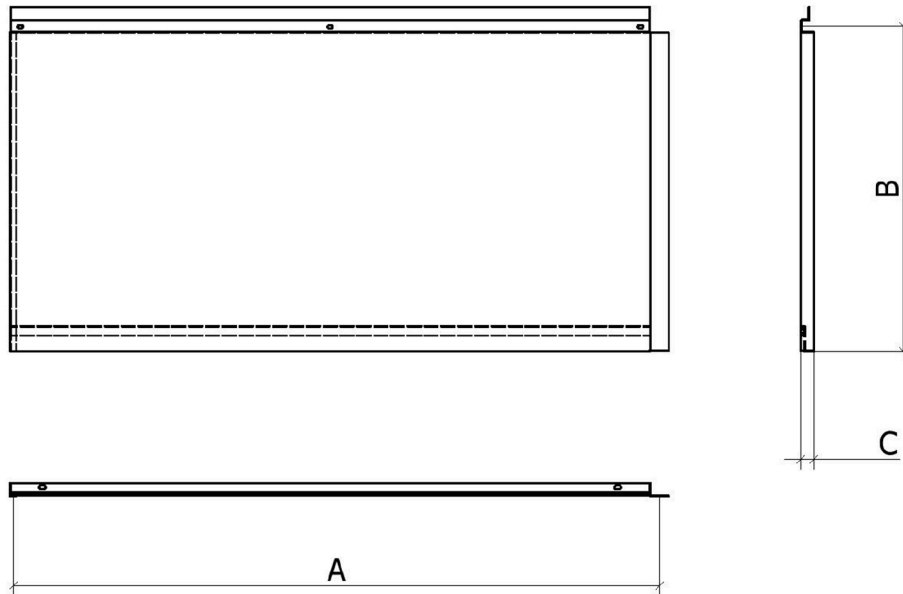

Pikkus / Length (A) (min/max) = 450 - 3000 4000 mm when required

Laius / Width (B) (min/max) = 450 - 900 mm

Sügavus / Height (C) (min/max) = 30 - 60 mm

Materjali paksus / Thickness range $t = 1,0 - 1,5$ mm

D1 = 0 - 20 mm / D2 = 10 - 30 mm

PARMET

Type :

L-105-A

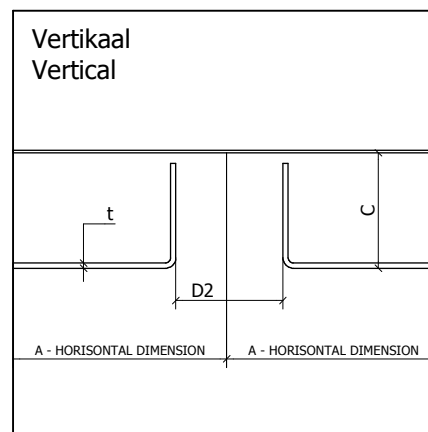
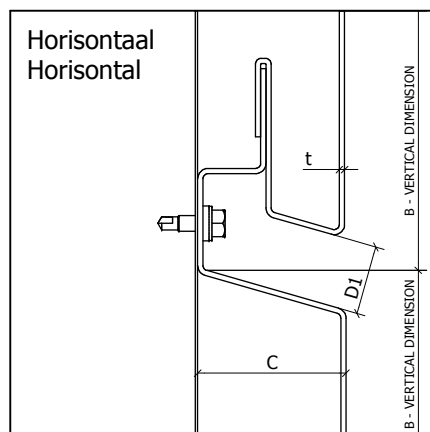
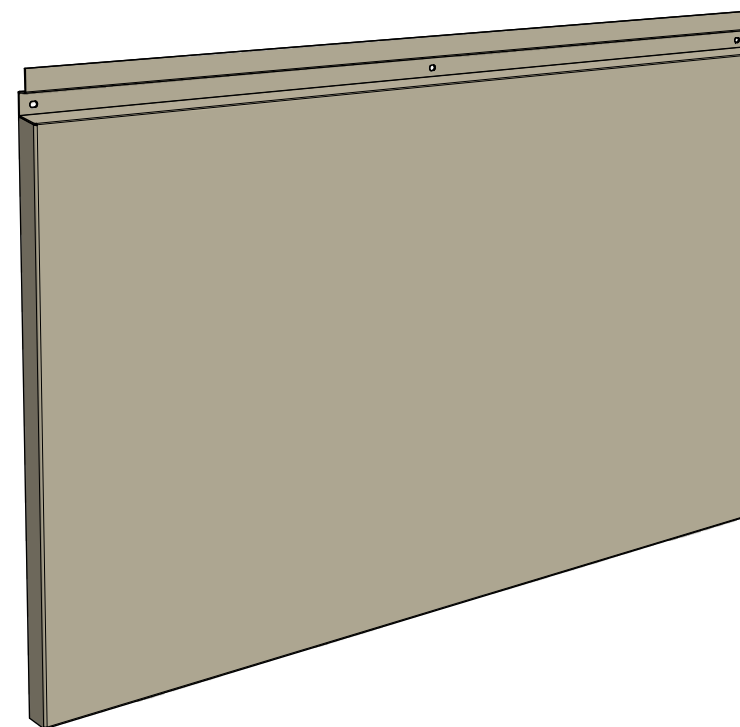
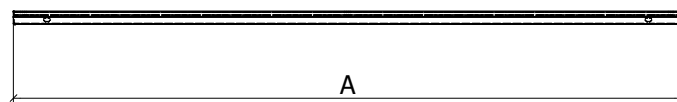
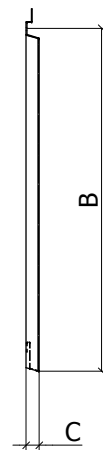
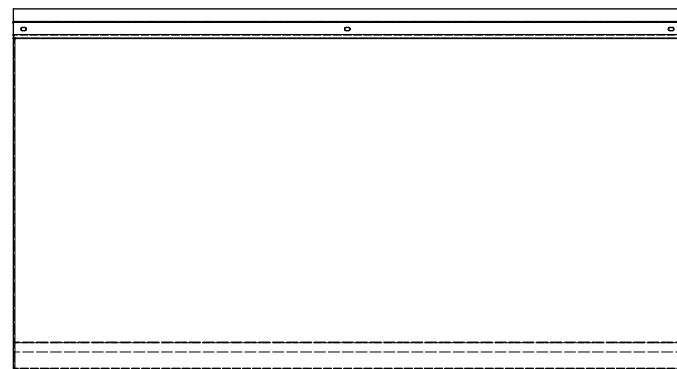

Pikkus / Length (A) (min/max) = 450 - 3000 mm

Laius / Width (B) (min/max) = 450 - 900 mm

Sügavus / Height (C) (min/max) = 30 - 60 mm

Materjali paksus / Thickness range $t = 1,0 - 1,5$ mm

D1 = 0 - 20 mm / D2 = 10 - 30 mm

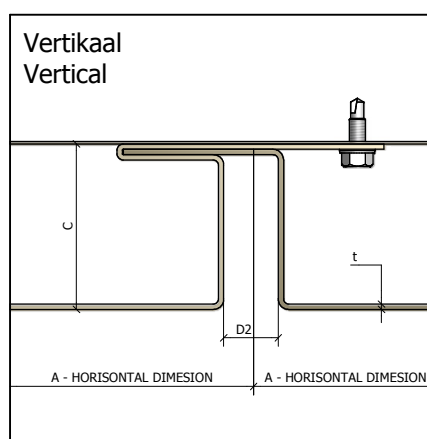
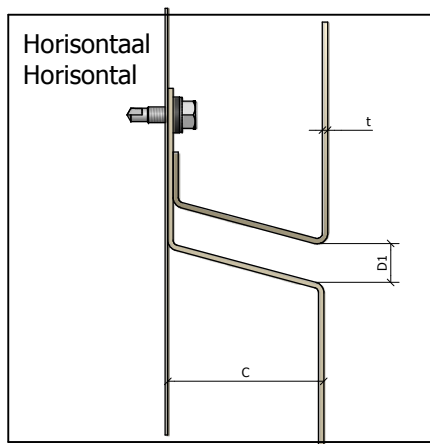
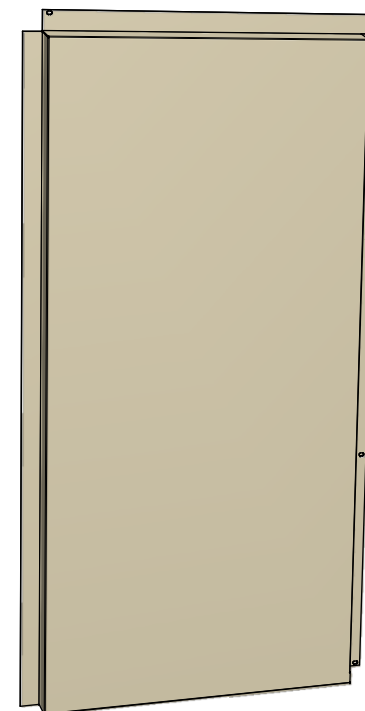
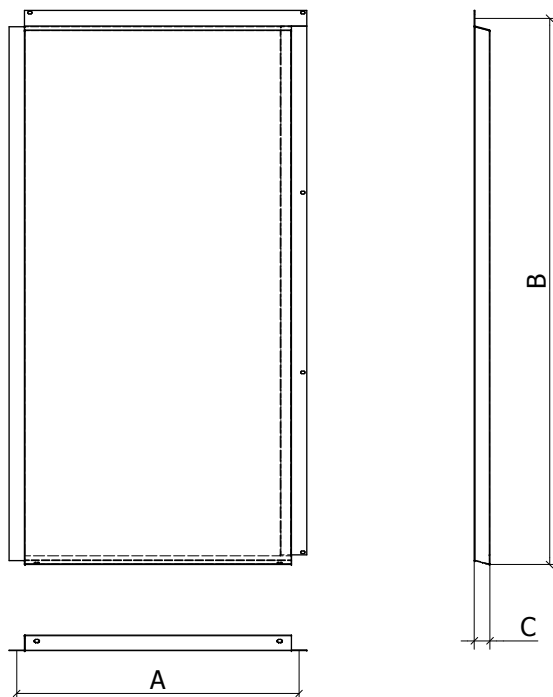

Pikkus / Length (A) (min/max) = 450 - 900 mm

Laius / Width (B) (min/max) = 450 - 3000 4000 mm when required

Sügavus / Height (C) (min/max) = 20 - 60 mm

Materjali paksus / Thickness range $t = 1,0 - 1,5$ mm

D1 = 0 - 20 mm / D2 = 10 - 20 mm

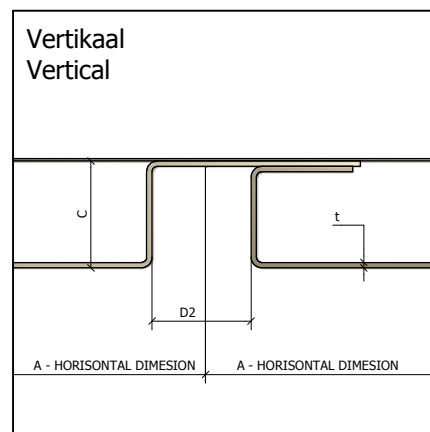
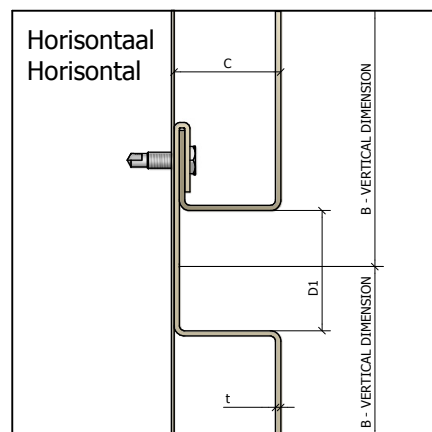
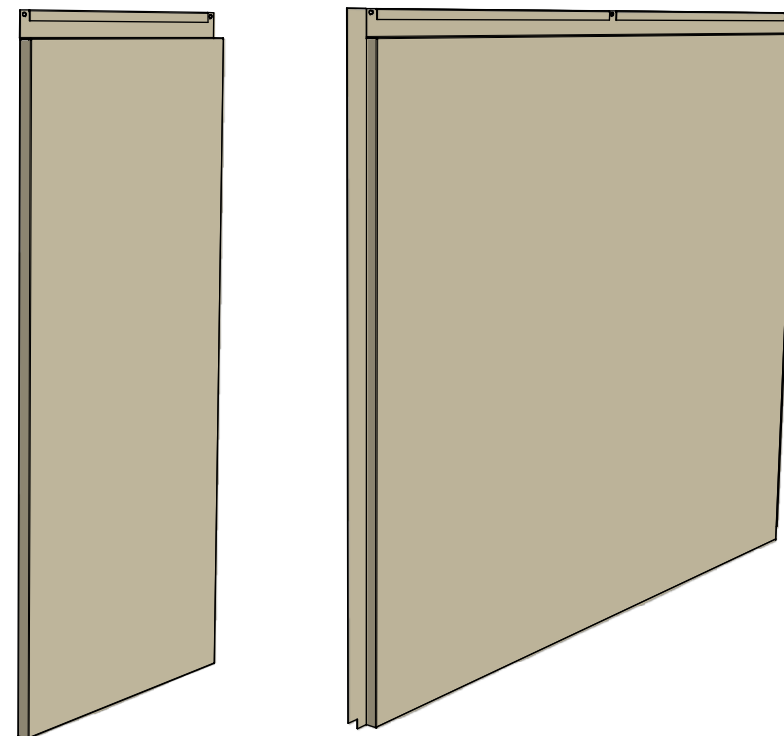
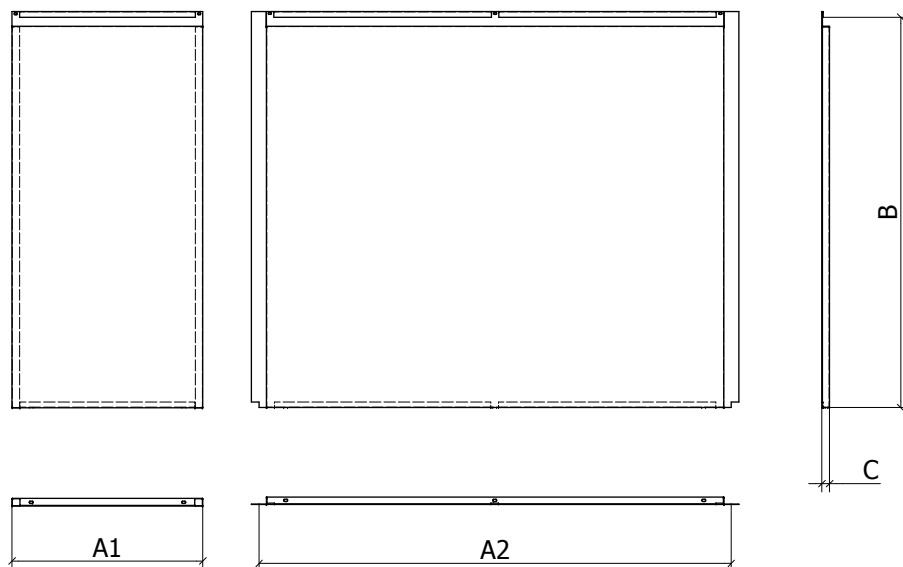

Pikkus / Length (A) (min/max) = 450 - 3000 4000 mm when required

Laius / Width (B) (min/max) = 450 - 900 mm

Sügavus / Height (C) (min/max) = 20 - 30 mm

Materjali paksus / Thickness range $t = 1,0 - 1,5$ mm

D1 = 15 - 30 mm / D2 = 15 - 30 mm

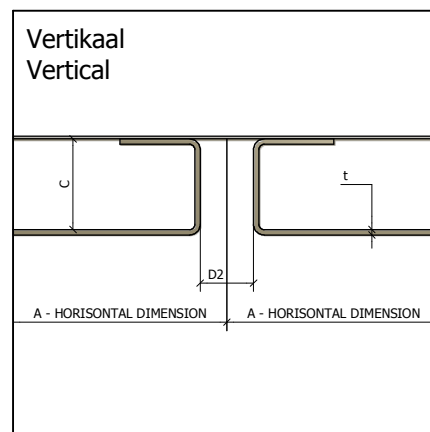
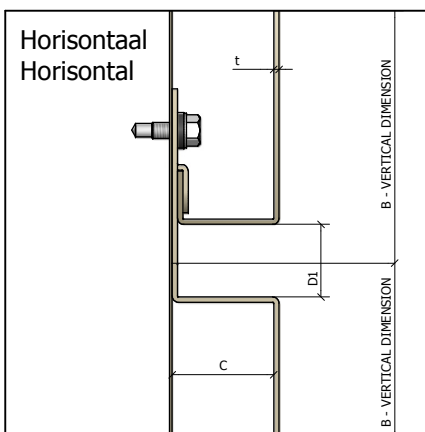
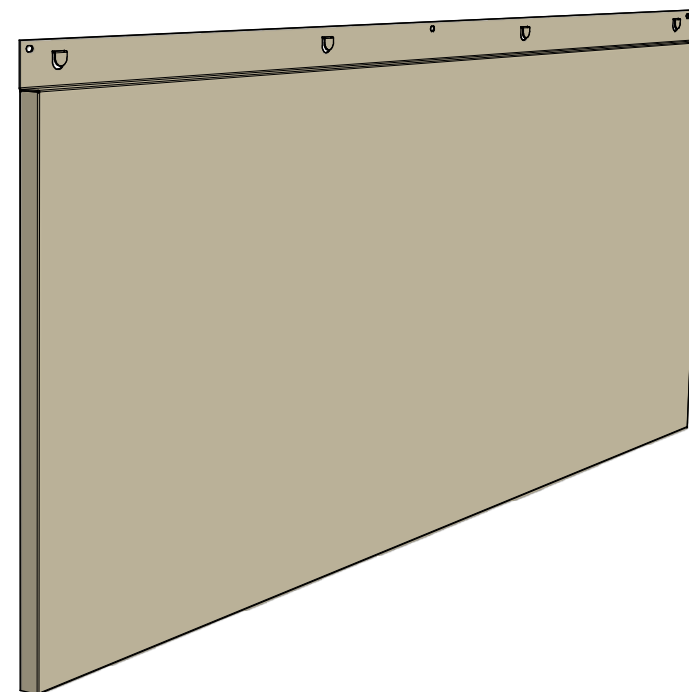
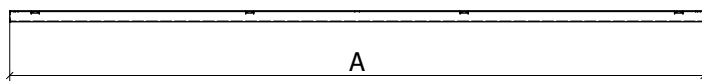
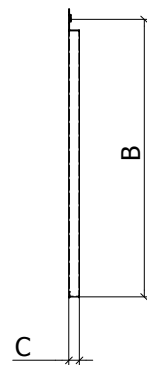
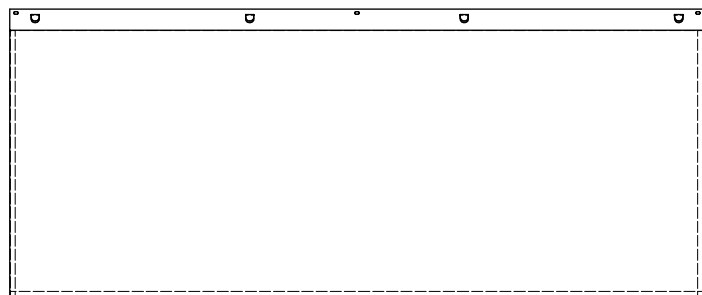

Pikkus / Length (A) (min/max) = 450 - 3000 4000 mm when required

Laius / Width (B) (min/max) = 300 - 700 mm

Sügavus / Height (C) (min/max) = 20 - 30 mm

Materjali paksus / Thickness range t = 1,0 - 1,2 mm

D1 = 10 - 30 mm / D2 = 0 - 30 mm

PARMET

Type :

L-150-A

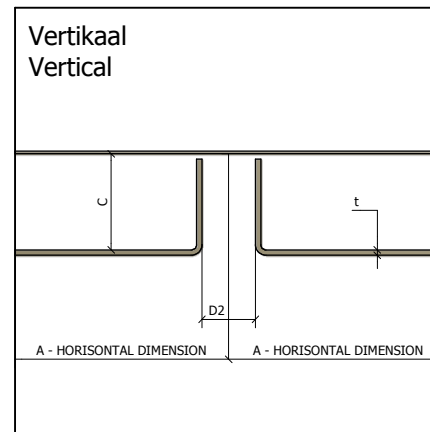
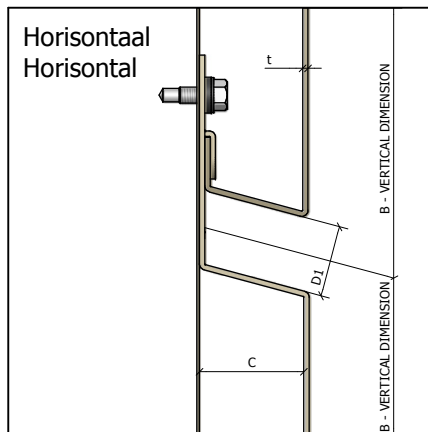
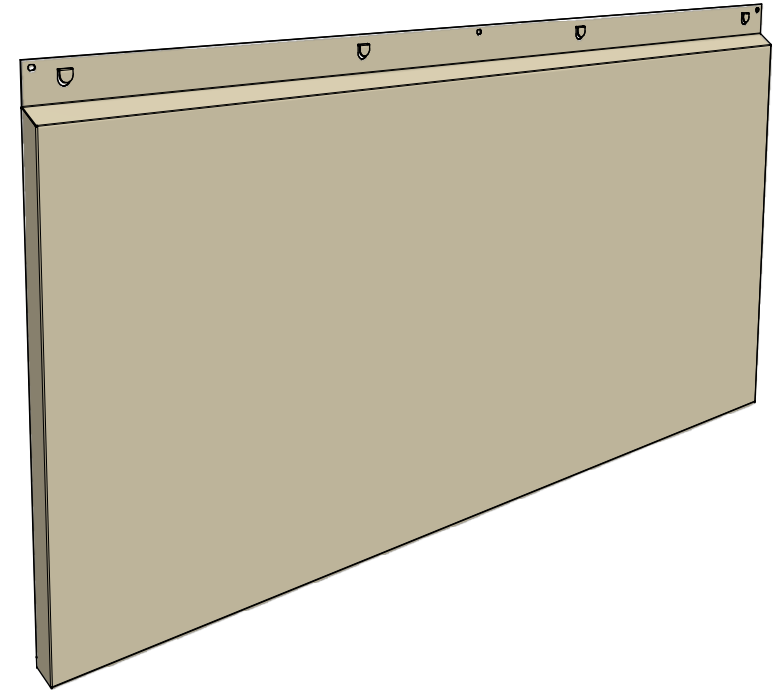
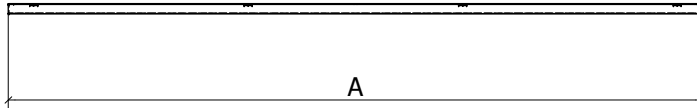
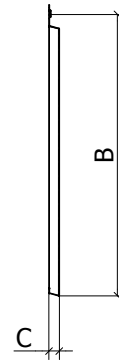
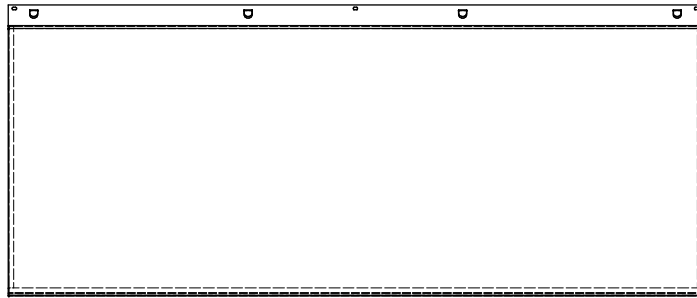

Pikkus / Length (A) (min/max) = 450 - 3000 4000 mm when required

Laius / Width (B) (min/max) = 300 - 700 mm

Sügavus / Height (C) (min/max) = 20 - 30 mm

Materjali paksus / Thickness range $t = 1,0 - 1,2$ mm

D1 = 10 - 30 mm / D2 = 0 - 30 mm

PARMET

Type :

L-150

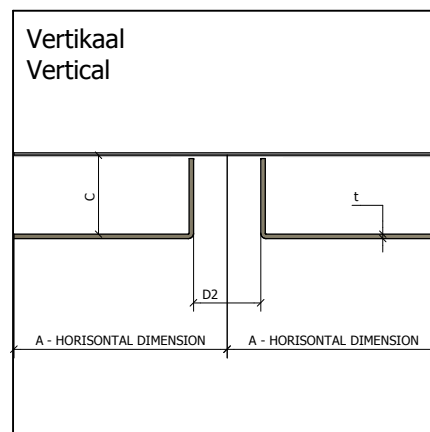
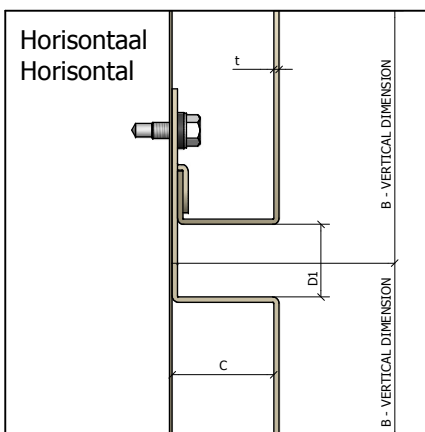
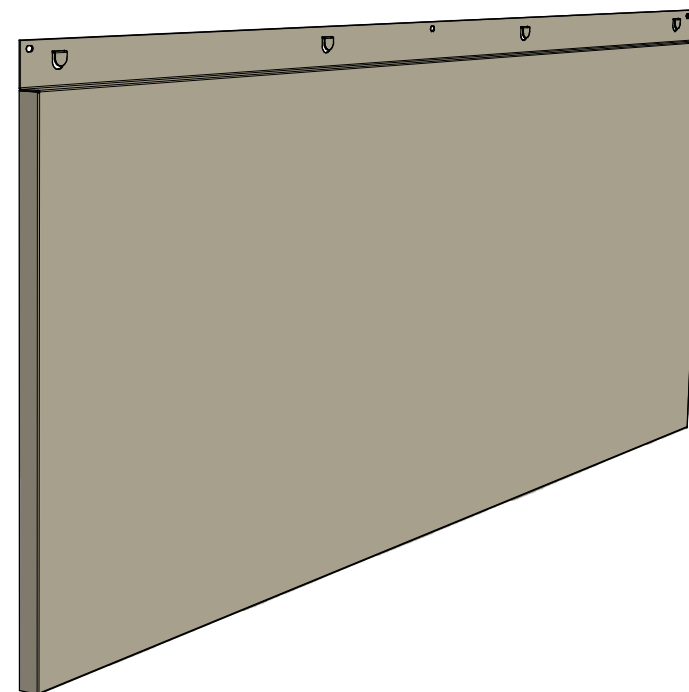
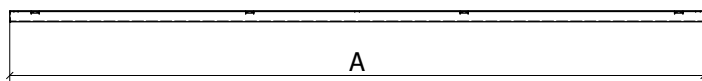
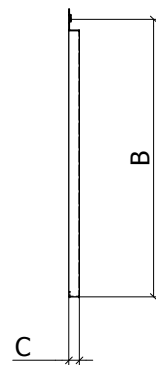
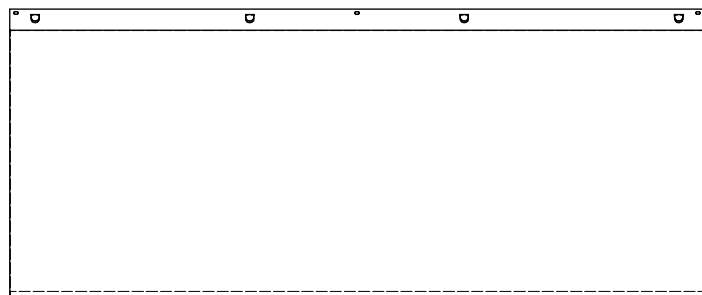

Pikkus / Length (A) (min/max) = 450 - 3000 mm 4000 mm when required

Laius / Width (B) (min/max) = 300 - 700 mm

Sügavus / Height (C) (min/max) = 20 - 30 mm

Materjali paksus / Thickness range $t = 1,0 - 1,2$ mm

D1 = 10 - 30 mm / D2 = 0 - 30 mm

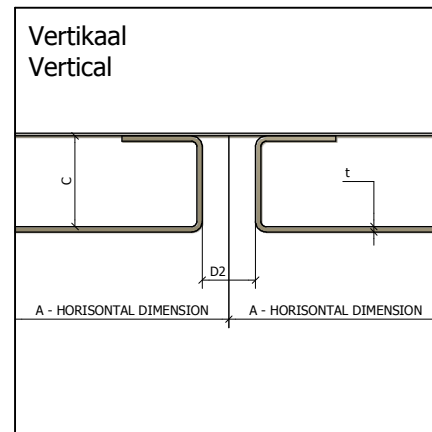
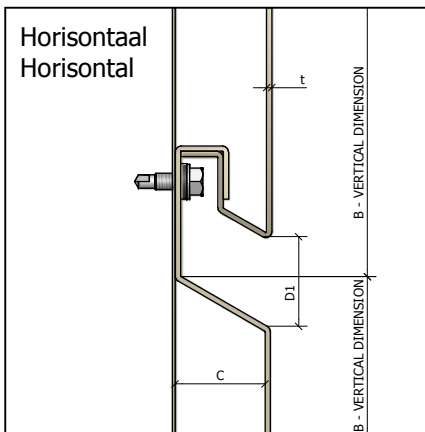
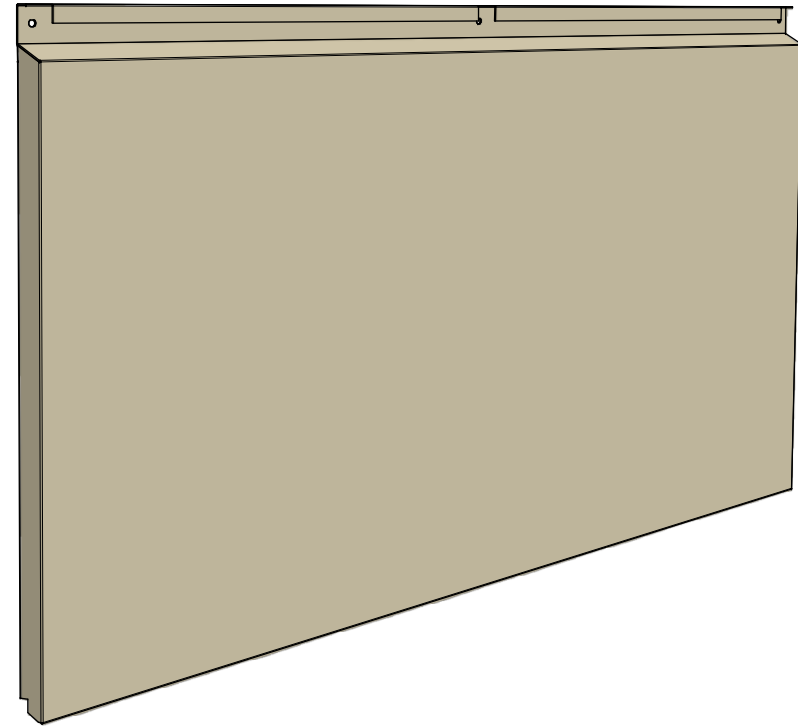
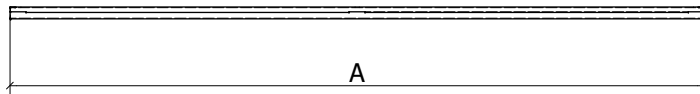
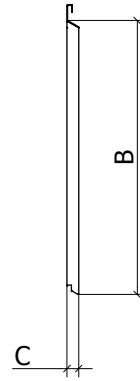
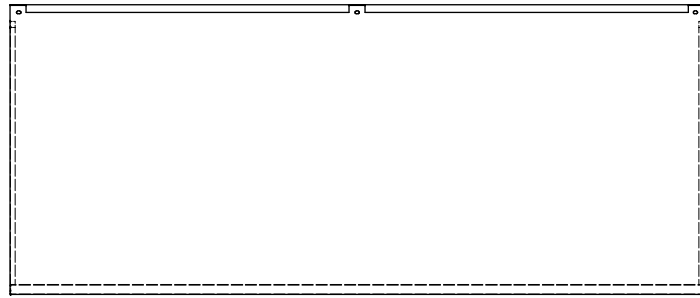

Pikkus / Length (A) (min/max) = 450 - 3000 4000 mm when required

Laius / Width (B) (min/max) = 450 - 900 mm

Sügavus / Height (C) (min/max) = 25 - 30 mm

Materjali paksus / Thickness range t = 1,0 - 1,5 mm

D1 = 20 - 25 mm / D2 = 0 - 30 mm

PARMET

Type :

L - 300

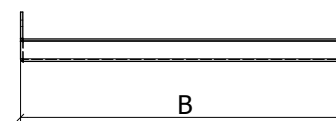
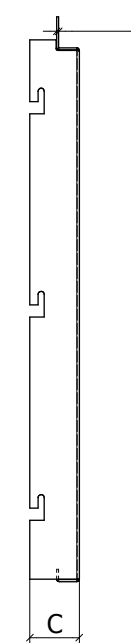
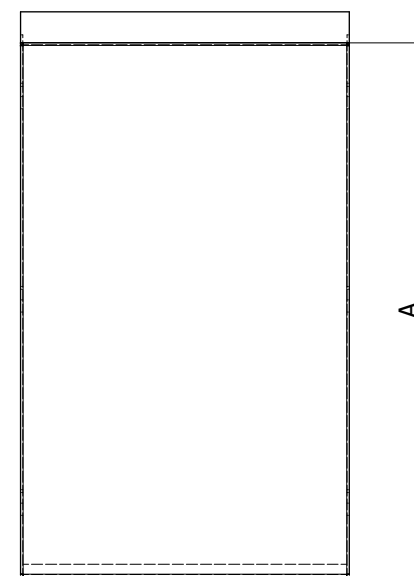
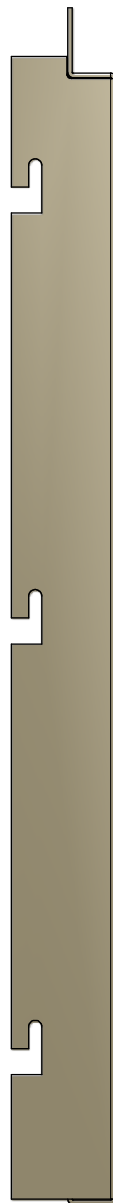
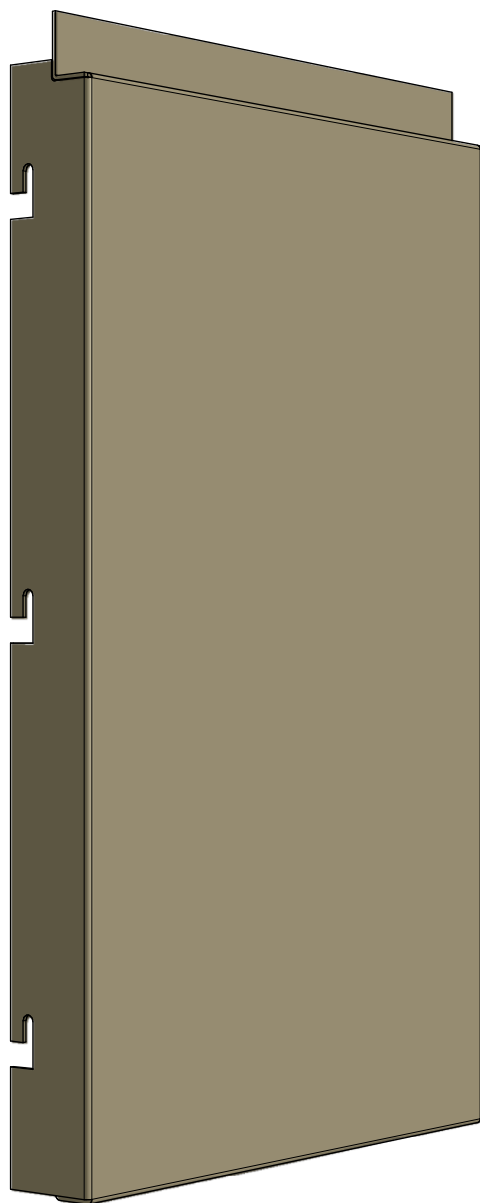

Pikkus / Length (A) (max) = 4000 mm
Laius / Width (B) (min/max) = 200 - 900 mm
Sügavus / Height (C) (min/max) = 50 mm
Materjali paksus / Thickness range t = 1,5 - 3,0 mm